

20 MIN

2 X

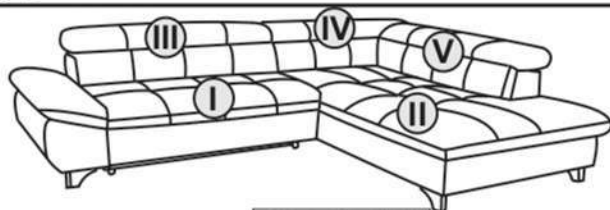
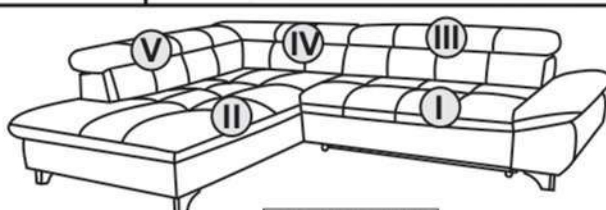

- (SK) POKYNY K MONTÁŽI
- (HU) ÖSSZESZERELÉSI ÚTMUTATÓ
- (SI) NAVODILA ZA MONTAŽO
- (RO) INSTRUCIUNI DE ASAMBLARE
- (HR) UPUTSTVA ZA MONTAŽU
- (CZ) POKYNY K MONTÁŽI

**SANA****3F-OTM****OTM-3F**

1/3

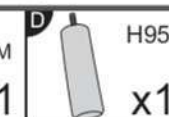
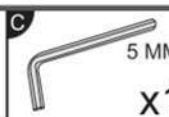
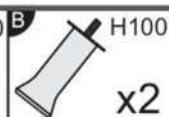
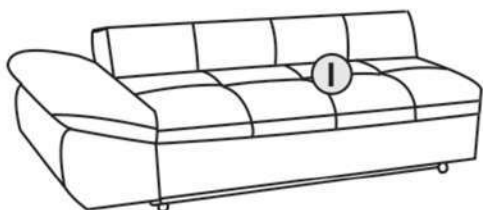
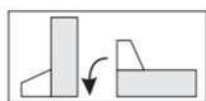
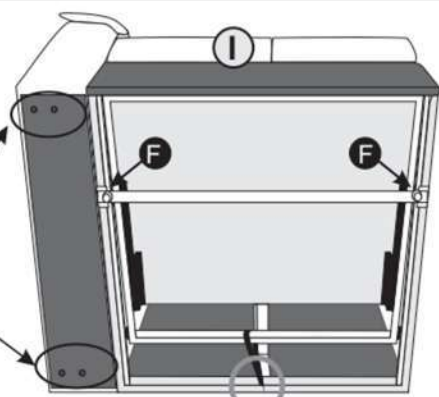
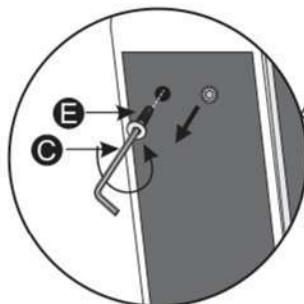
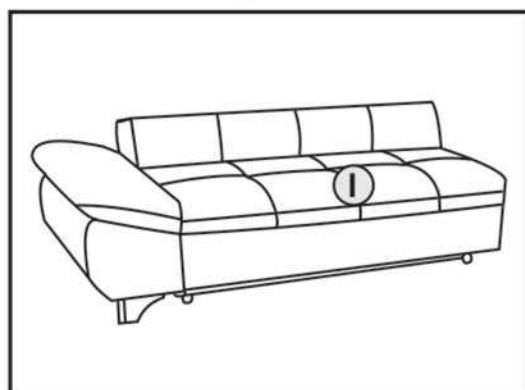
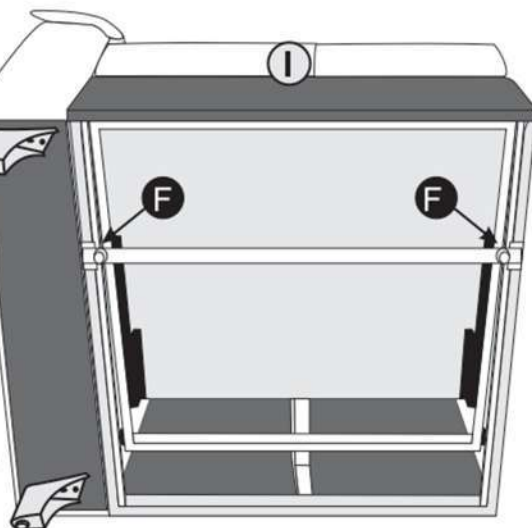
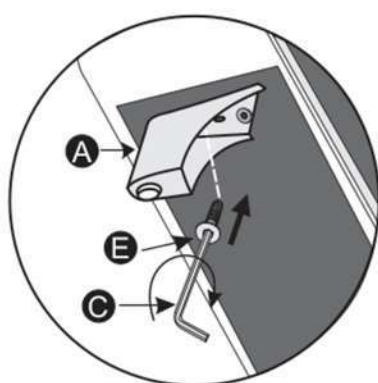
**1****2****3**

20 MIN

2 X



- (SK) POKYNY K MONTÁŽI
- (HU) ÖSSZESZERELÉSI ÚTMUTATÓ
- (SI) NAVODILA ZA MONTAŽO
- (RO) INSTRUCIUNI DE ASAMBLARE
- (HR) UPUTSTVA ZA MONTAŽU
- (CZ) POKYNY K MONTÁŽI

# SANA

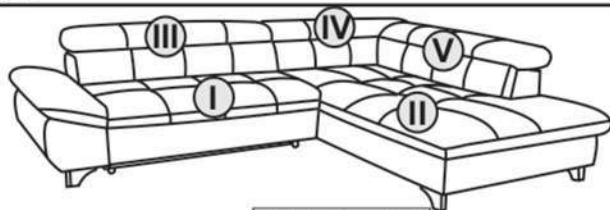

3F-OTM

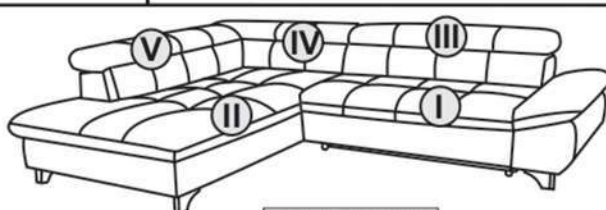

OTM-3F

2/3

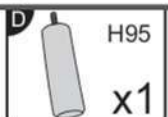
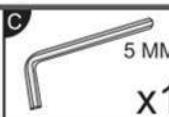
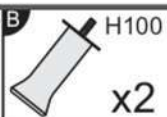

4

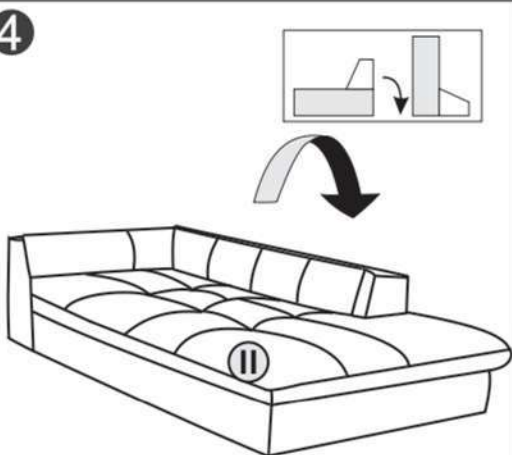

5

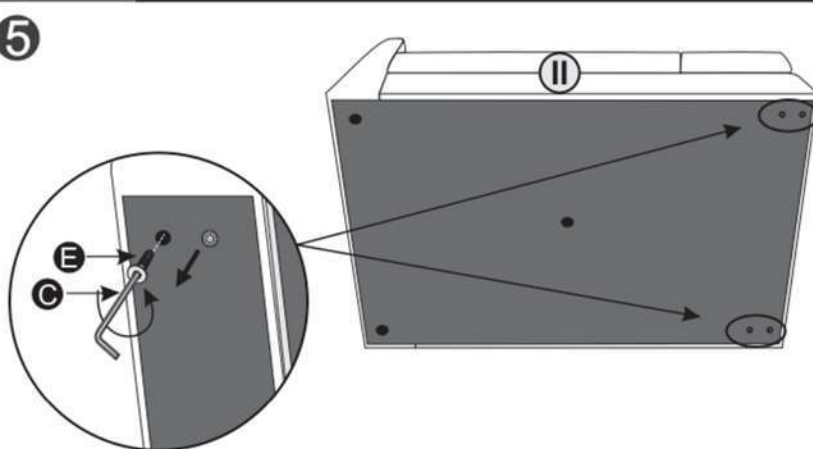

6

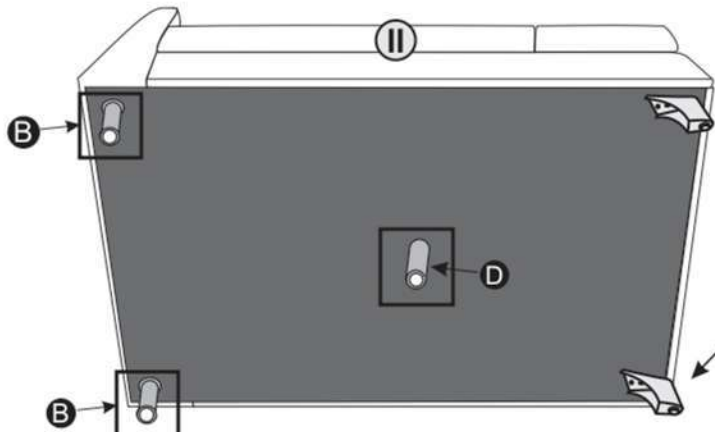
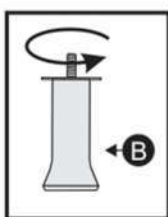
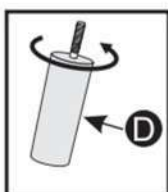

7

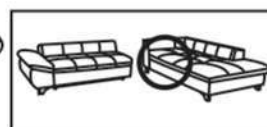
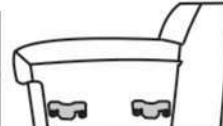
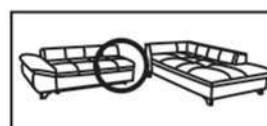
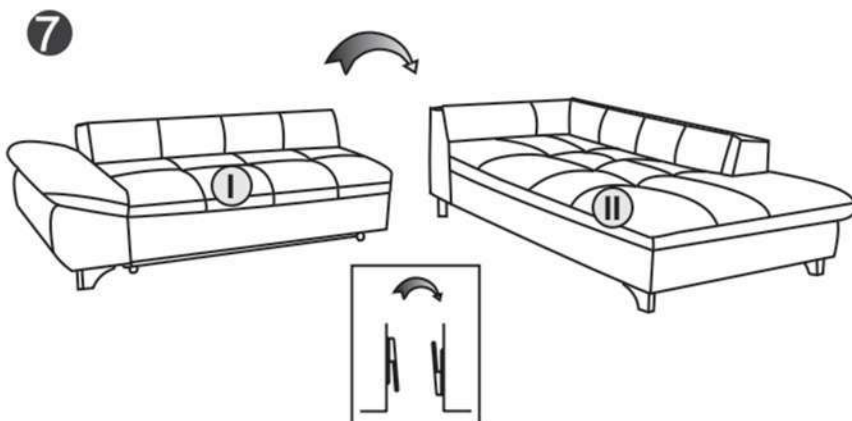

20 MIN

2 X



- SK POKYNY K MONTÁŽI
- HU ÖSSZESZERELÉSI ÚTMUTATÓ
- SI NAVODILA ZA MONTAŽO
- RO INSTRUCIUNI DE ASAMBLARE
- HR UPUTSTVA ZA MONTAŽU
- CZ POKYNY K MONTÁŽI

# SANA

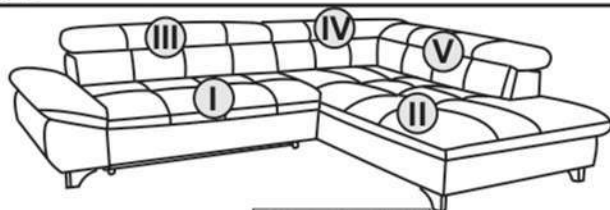

3F-OTM

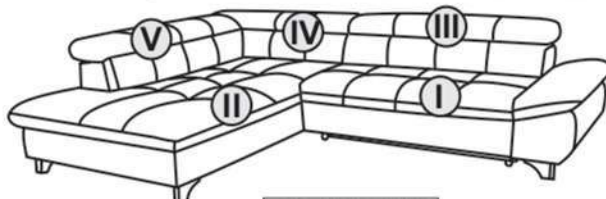

OTM-3F

3/3

8

1/3

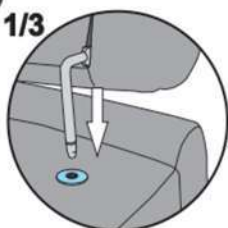

2/3



3/3

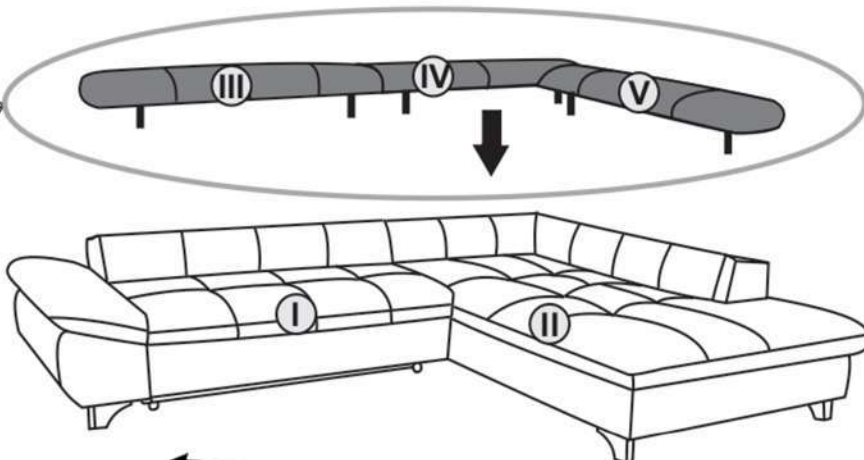

9

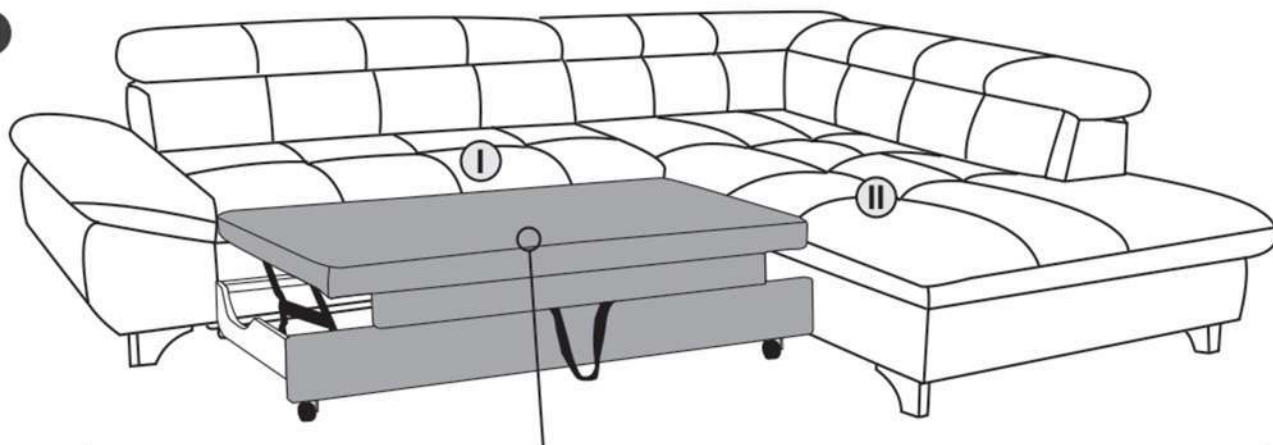

1/4

2/4

3/4

4/4

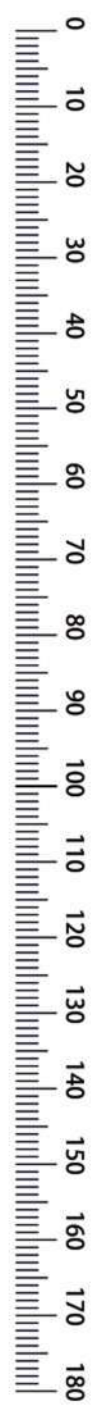
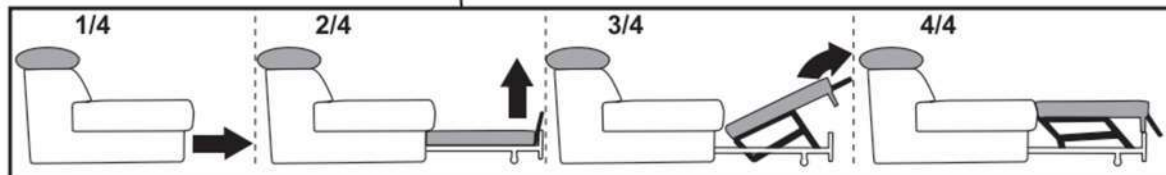

20 MIN

2 X

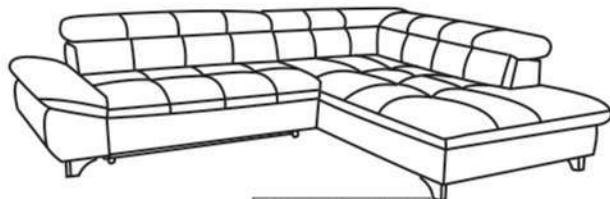
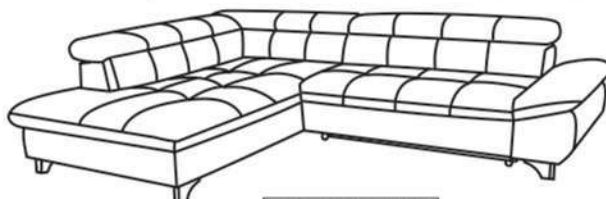

- (SK) POKYNY K MONTÁŽI
- (HU) ÖSSZESZERELÉSI ÚTMUTATÓ
- (SI) NAVODILA ZA MONTAŽO
- (RO) INSTRUCIUNI DE ASAMBLARE
- (HR) UPUTSTVA ZA MONTAŽU
- (CZ) POKYNY K MONTÁŽI

**SANA****3F-OTM****OTM-3F****SK:**

VÝROBOK JE URČENÝ NA POUŽITIE V DOMÁCNOSTI.

PO MONTÁŽI TOHTO VÝROBKU ODPORÚČAME NIEKOĽKO DNÍ PRAVIDELNE VETRAŤ MIESTNOSŤ.

NEBEZPEČENSTVO PRITLAČENIA PRI ZATVÁRANÍ KRABICE.

**HR:**

PROIZVOD JE NAMIJENJEN ZA UPORABU U KUĆANSTVU.

NAKON SASTAVLJANJA OVOG PROIZVODA, PREPORUČLJIVO JE REDOVITO PROZRAČIVATI PROSTORIJU NEKOLIKO DANA.

OPASNOST OD PRIKLJEŠTENJA PRILIKOM ZATVARANJA KUTIJE.

**RO:**

PRODUSUL ESTE DESTINAT UZULUI CASNIC.

DUPĂ ASAMBLAREA ACESTUI PRODUS, ESTE INDICAT SĂ AERISIȚI CAMERA ÎN MOD REGULAT TIMP DE CĂTEVA ZILE.

EXISTĂ RISCUL DE A FI CIUPIT LA ÎNCHIDEREA CUTIEI.

**SI:**

IZDELEK JE NAMENJEN ZA DOMAČO UPORABO.

PO MONTAŽI IZDELKA JE PRIPOROČLJIVO NEKAJ DNI REDNO PREZRAČEVATI PROSTOR.

NEVARNOST UKLEŠČENJA PRI ZAPIRANJU ŠKATLE.

**HU:**

A TERMÉK OTTHONI HASZNÁLATRA KÉSZÜLT.

A TERMÉK ÖSSZESZERELÉSE UTÁN AJÁNLOTT NÉHÁNY NAPIG RENDSZERESEN SZELLŐZTETNI A HELYSÉGET.

A DOBOZ ZÁRÁSAKOR BECSÍPÖDÉS VESZÉLYE ÁLL FENN.

**CZ:**

VÝROBEK JE URČEN K POUŽITÍ V DOMÁCNOSTI.

PO MONTÁŽI TOHTO VÝROBKU DOPORUČUJEME NĚKOLIK DNÍ PRAVIDELNĚ VĚTRAT MÍSTNOST.

NEBEZPEČÍ PŘITLAČENÍ PŘI ZAVÍRÁNÍ KRABICE.

